

RIFLE

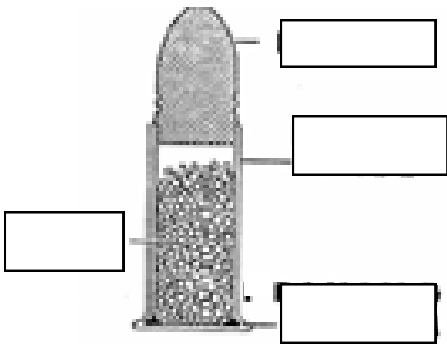
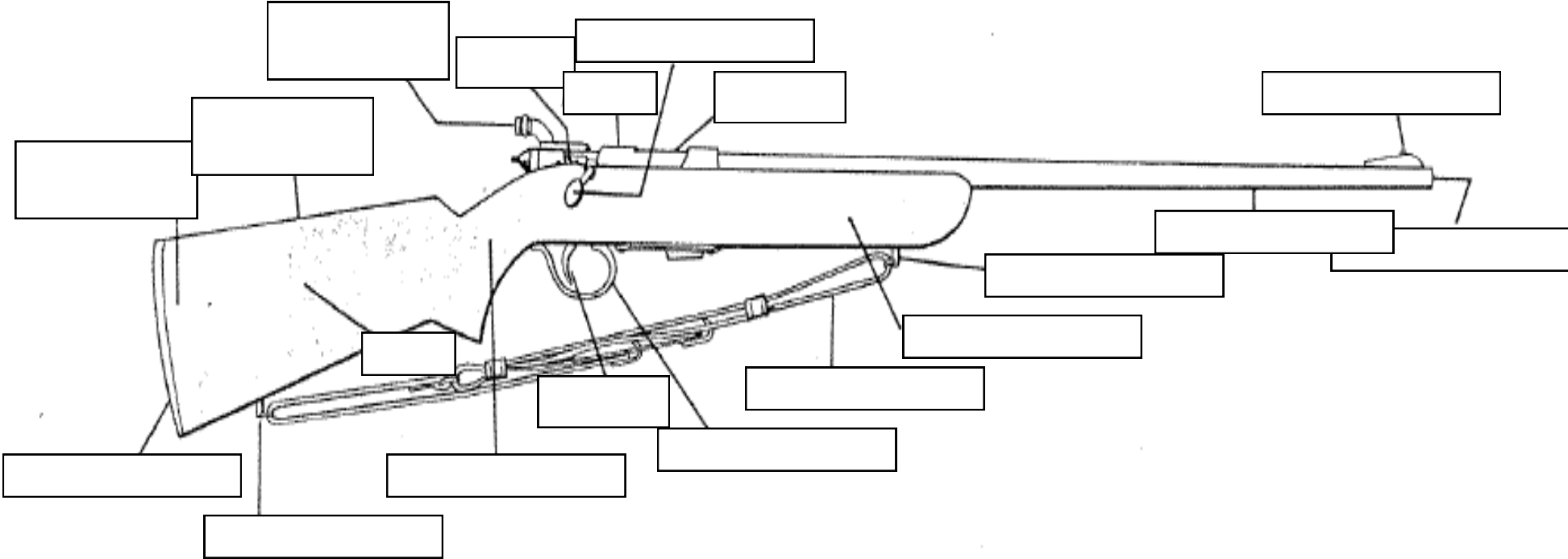

- A. Bullet
- B. Primer
- C. Powder
- D. Brass Case

22 Rim fire cartridge

1	Action		11	Muzzle
2	Barrel		12	Rear Peep Sight
3	Bolt		13	Rear Swivel
4	Bolt Handle		14	Safety
5	Butt of Stock		15	Sling Strap
6	Butt Plate		16	Small of Stock
7	Comb of Stock		17	Stock
8	Fore-end		18	Tigger Guard
9	Front Sight		19	Trigger
10	Front Swivel			

RIFLE

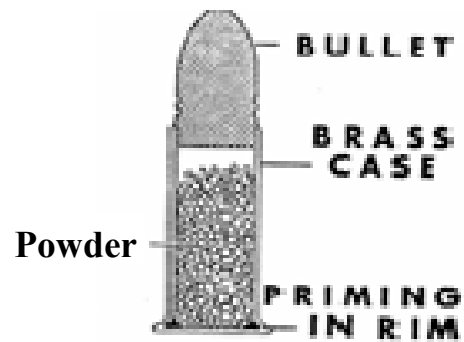
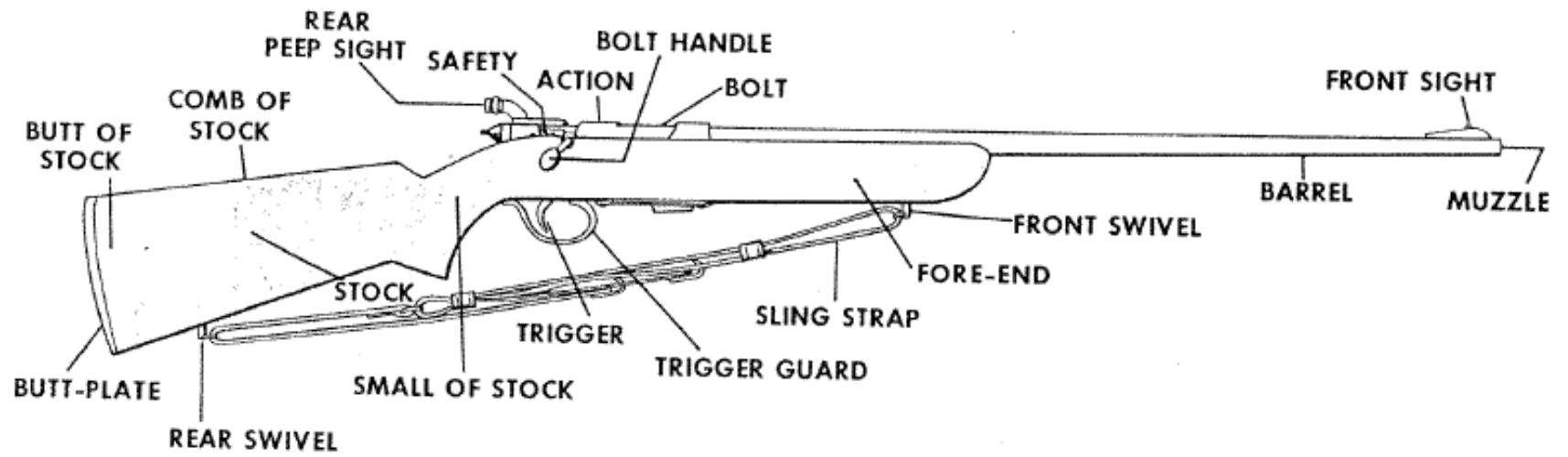

22 Rim fire cartridge

PUT THE NUMBER OF THE PART IN THE BOX.

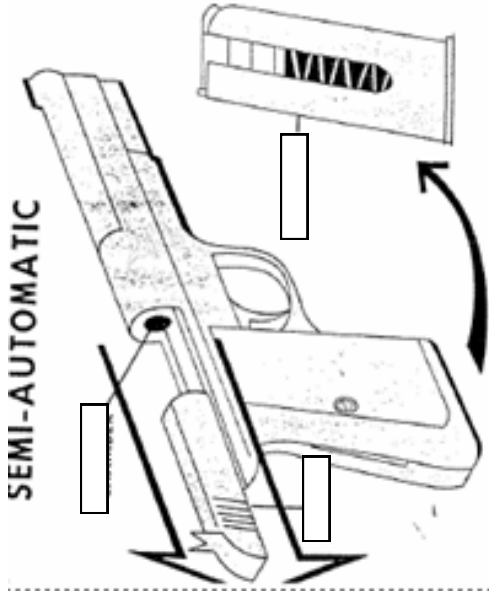

SEMI-AUTOMATIC

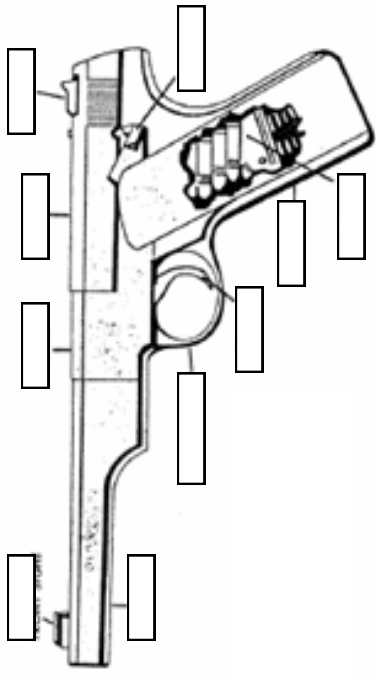

REVOLVER

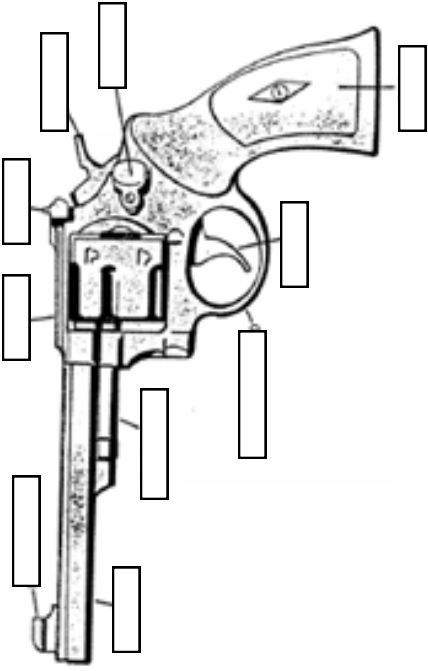
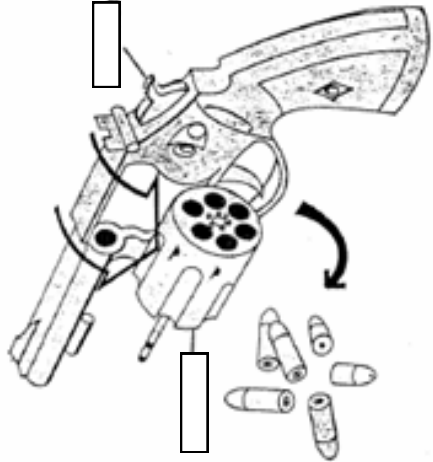

1	Barrel
2	Chamber
3	Cylinder
4	Cylinder Thumb Latch
5	Ejector Rod
6	Frame
7	Front Sight
8	Grip
9	Hammer
10	Magazine
11	Rear Sight
12	Safety
13	Slide
14	Top Strap
15	Trigger
16	Trigger Guard

Note: Some parts will be used more than once.

SEMI-AUTOMATIC

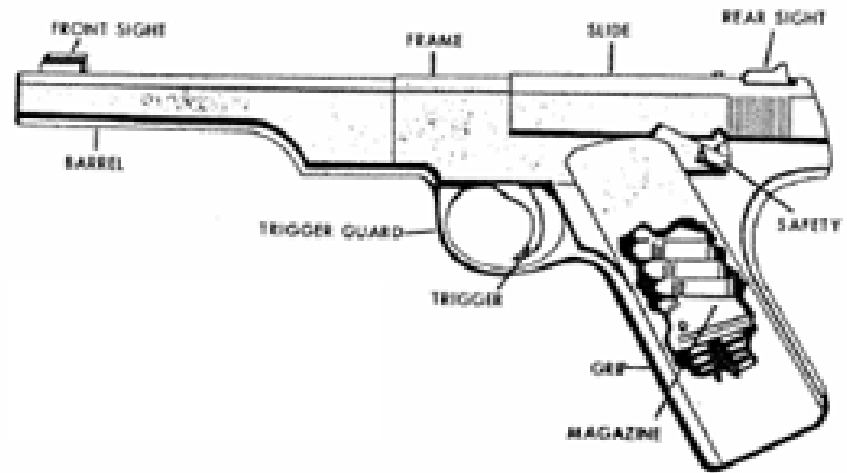

REVOLVER

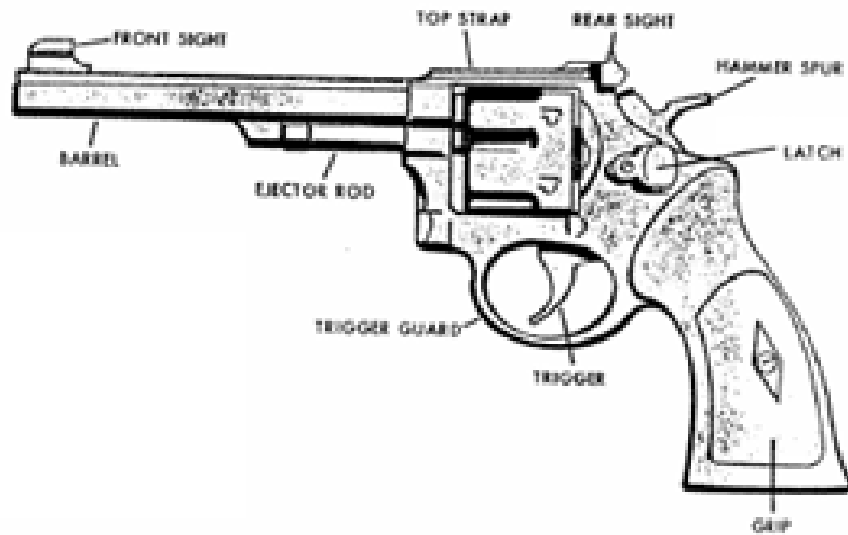
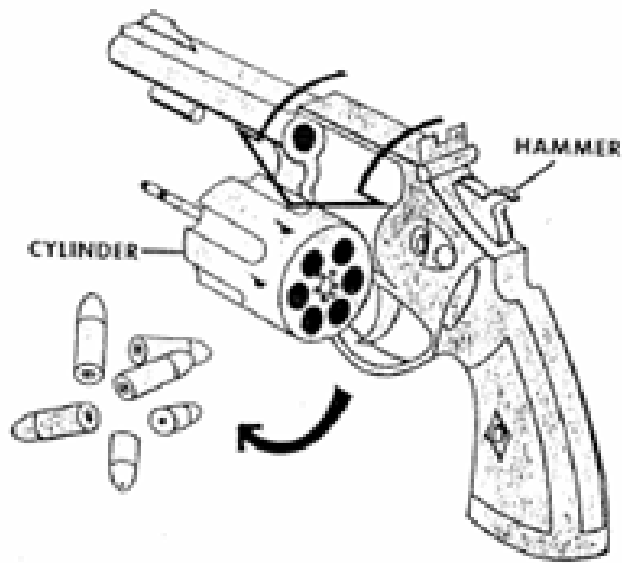

Parts of a Muzzleloading Flintlock Rifle

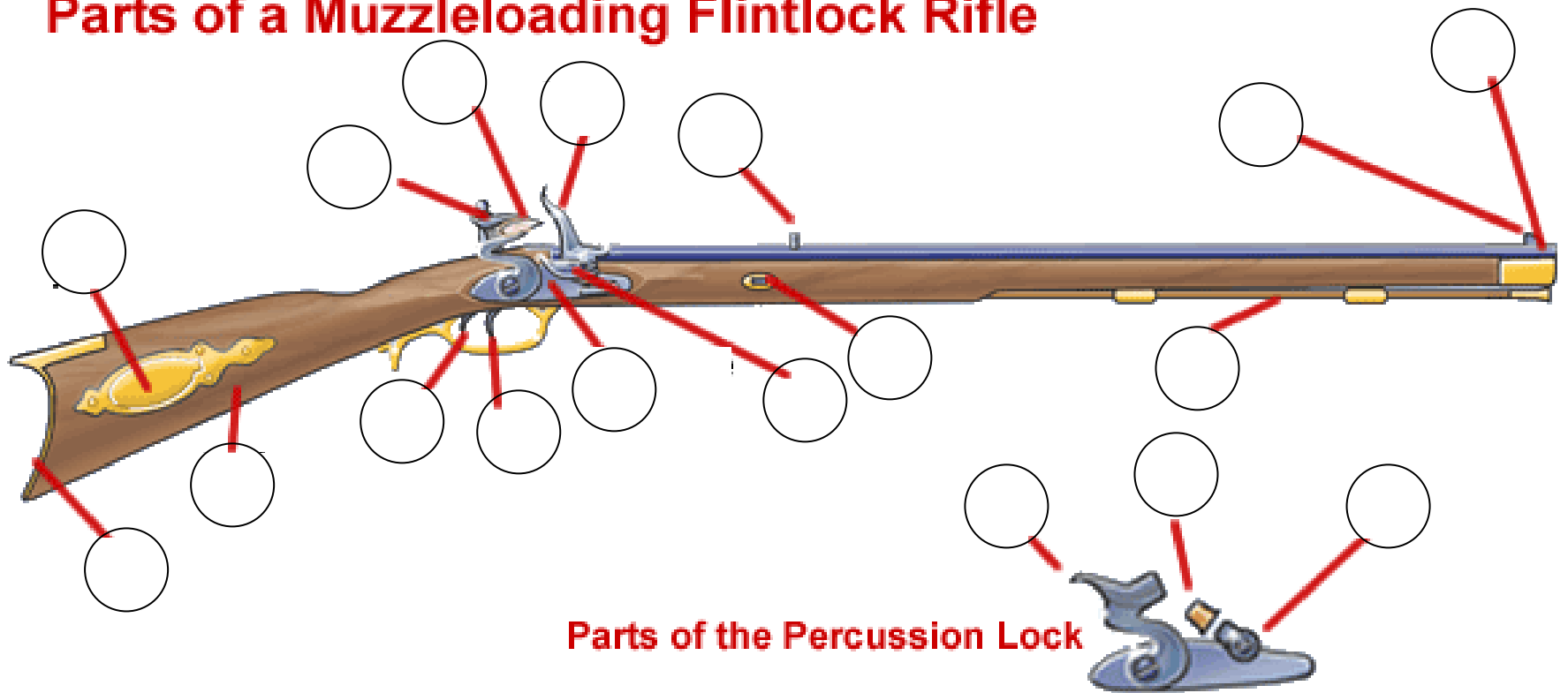

Parts of the Percussion Lock

- | | |
|---------------|----------------|
| 1 butt plate | 10 muzzle |
| 2 cap | 11 nipple |
| 3 cock | 12 pan |
| 4 cock | 13 patch box |
| 5 frizzen | 14 ramrod |
| 6 front sight | 15 rear sight |
| 7 key/wedge | 16 set trigger |
| 8 lock | 17 stock |
| 9 lock plate | 18 trigger |

Parts of a Muzzleloading Flintlock Rifle

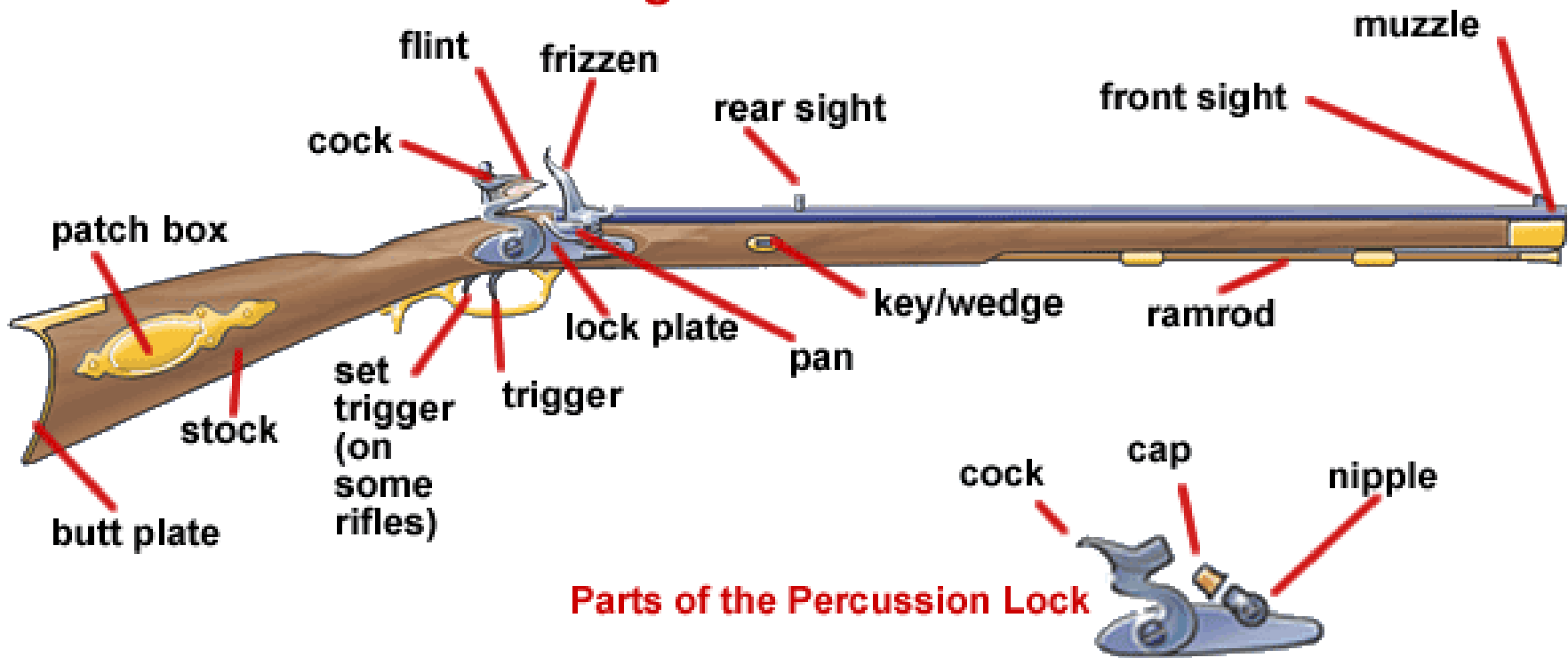

SHOTGUN

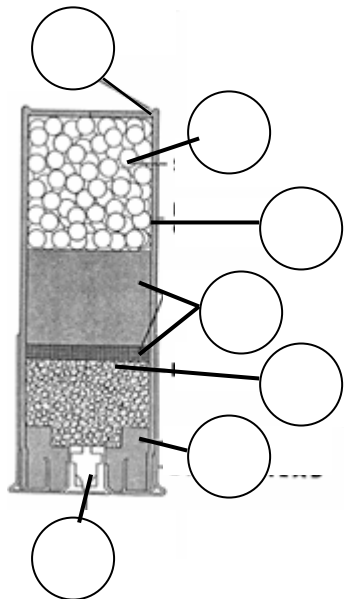
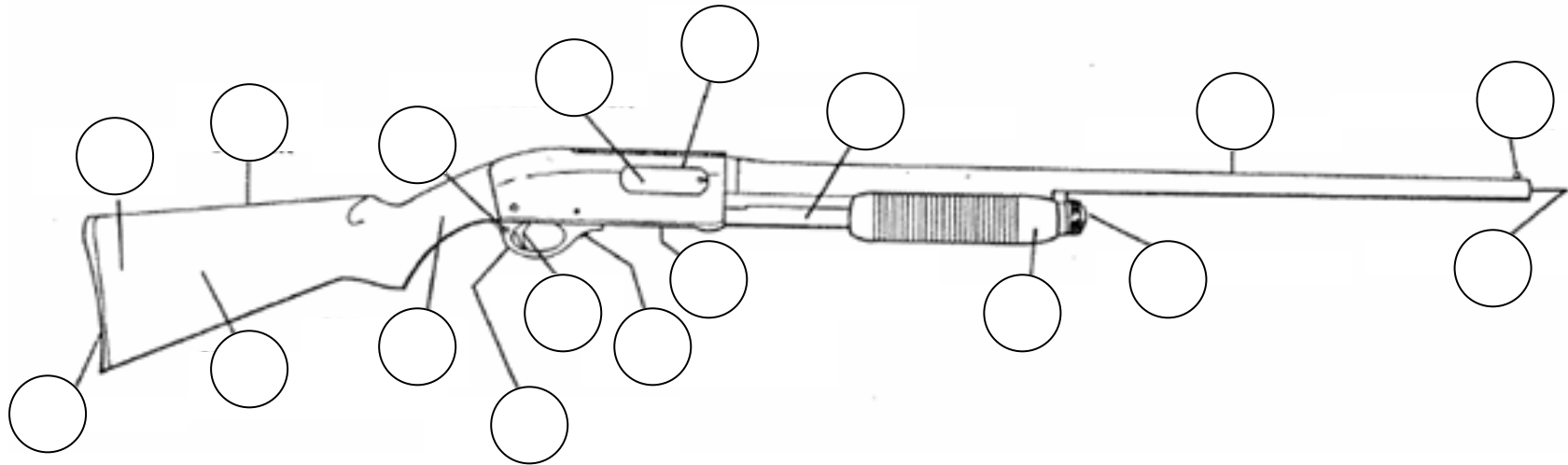

- | | | |
|-----------------------------|--------------------------|---------------|
| 1 Barrel | 10 Magazine Cap | 19 Base wad |
| 2 Breech Block | 11 Magazine Loading Port | 20 Brass Head |
| 3 Butt of Stock | 12 Muzzle | 21 Crimp |
| 4 Butt Plate | 13 Pump Action Release | 22 Paper Case |
| 5 Comb of Stock | 14 Safety | 23 Powder |
| 6 Fore End | 15 Small of Stock | 24 Primer |
| 7 Front Sight | 16 Stock | 25 Shot |
| 8 Loading and Ejection Port | 17 Trigger | 26 Wads |
| 9 Magazine | 18 Trigger Guard | |

SHOTGUN

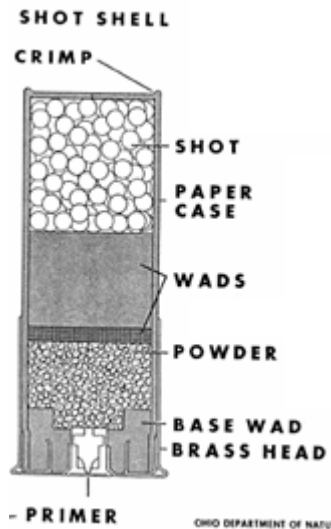
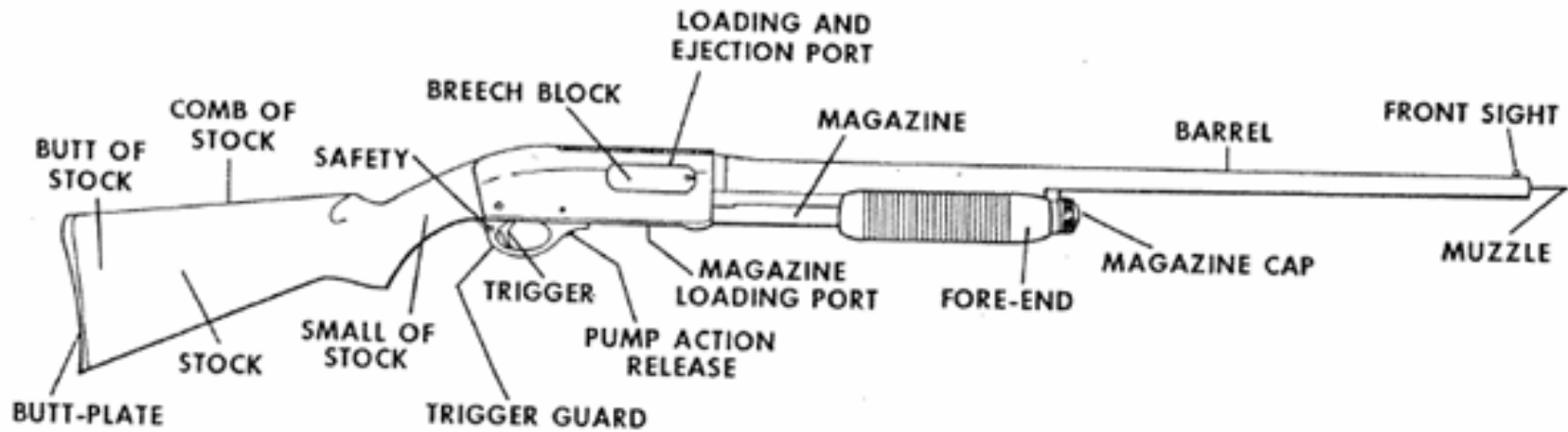

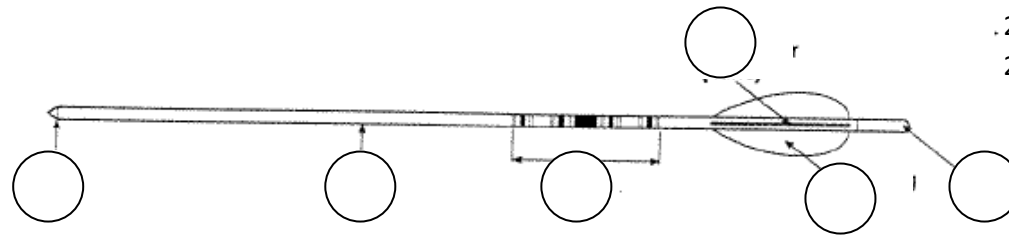
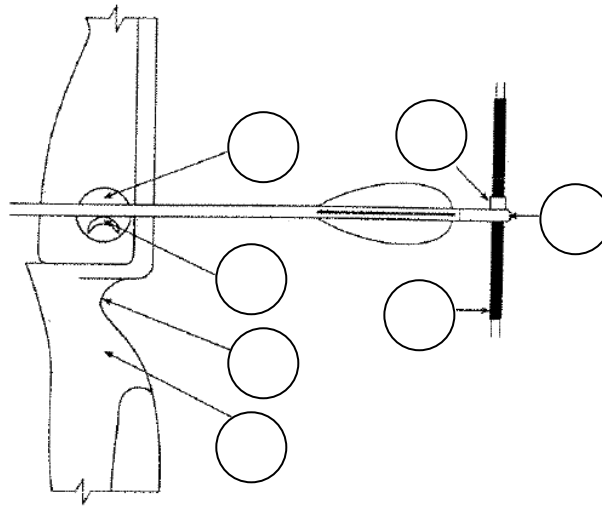
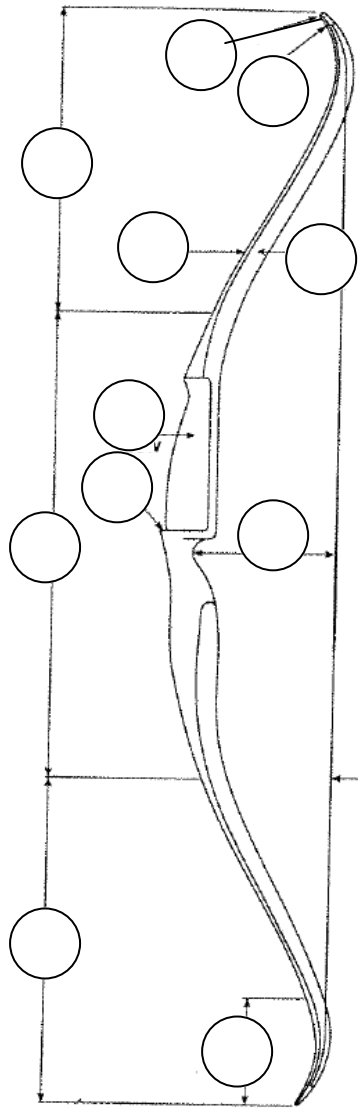

- 1 Arrow Plate
- 2 Arrow Rest
- 3 Back
- 4 Center Serving
- 5 Crest
- 6 Face
- 7 Fletching
- 8 Grip
- 9 Index Feather (Vane)
- 10 Lower Limb
- 11 Nock
- 12 Nock Locator
- 13 Nocking Point
- 14 Pivot Point
- 15 Point
- 16 Recurve
- 17 Riser
- 18 Shaft
- 19 Shelf
- 20 Sight Window
- 21 String
- 22 String Height
- 23 String Notch
- 24 Tip
- 25 Upper Limb

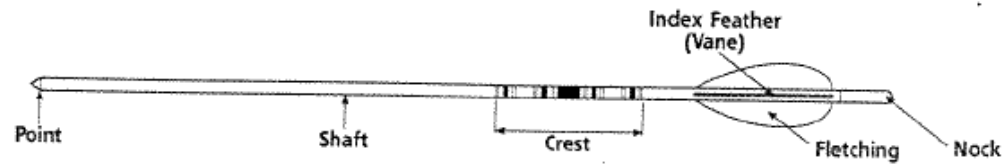
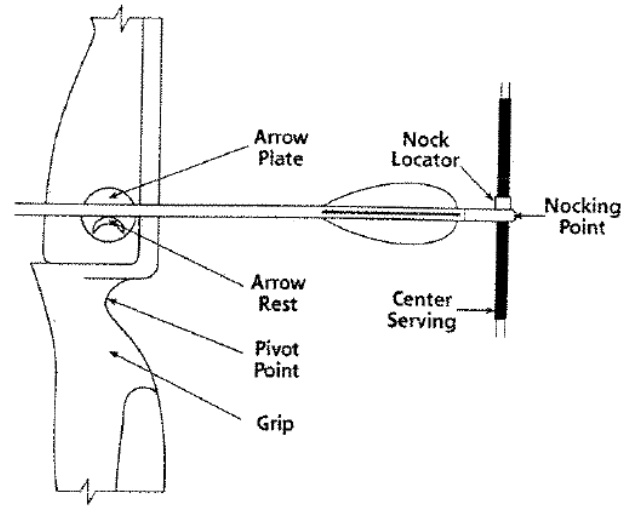
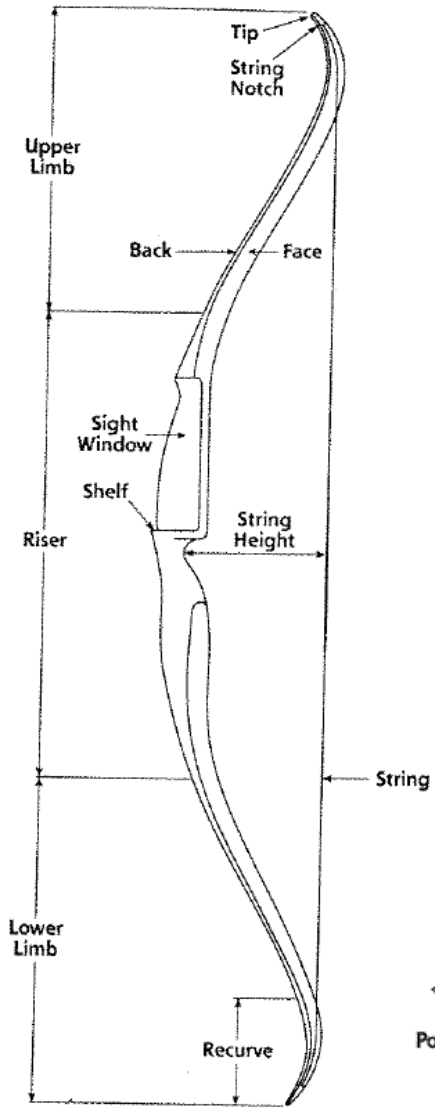

SAFETY

Circle the correct answer:

1. The Range Officer is the only person who can yell Cease Fire on the range. True False

2. The person most responsible for firearms safety is...
 - a. The 4-H Leader
 - b. The Range officer
 - c. The Shooter
 - d. Local police

3. Cease Fire means to:
 - a. Pick up your firearm and begin firing
 - b. Stop firing and put down your firearm

4. The Safety on a firearm always prevents it from firing when you pull the trigger. True False

5. You should wash your hands after shooting because...
 - a. the oil on the firearm can irritate your skin
 - b. lead from the bullet is harmful to your health
 - c. other people may have handled the firearm before you

6. How do you check to see if a gun is loaded?
 - a. Pull the trigger
 - b. Remove or empty the magazine as appropriate, open and visually check the action
 - c. Look down the barrel and visually check
 - d. Count the number of cartridges still in the magazine
 - e. All of the above

7. The three cardinal rules of 4-H gun safety are: (choose one under each rule)

Rule 1	Rule 2	Rule 3
a. Keep the muzzle pointed up	a. Keep the action open until ready to fire	a. Keep finger in the trigger guard at all times
b. Keep the muzzle pointed down	b. Keep the action closed until ready to fire	b. Keep your finger off the trigger until ready to fire
c. Keep the muzzle pointed in a safe direction	c. Close the action when finished shooting	c. Keep your finger on the trigger while aiming

SAFETY

Circle the correct answer:

1. The Range Officer is the only person who can yell Cease Fire on the range. True False

2. The person most responsible for firearms safety is...
 - a. The 4-H Leader
 - b. The Range officer
 - c. The Shooter
 - d. Local police

3. Cease Fire means to:
 - a. Pick up your firearm and begin firing
 - b. Stop firing and put down your firearm

4. The Safety on a firearm always prevents it from firing when you pull the trigger. True False

5. You should wash your hands after shooting because...
 - a. the oil on the firearm can irritate your skin
 - b. lead from the bullet is harmful to your health
 - c. other people may have handled the firearm before you

6. How do you check to see if a gun is loaded?
 - a. Pull the trigger
 - b. Remove or empty the magazine as appropriate, open and visually check the action
 - c. Look down the barrel and visually check
 - d. Count the number of cartridges still in the magazine
 - e. All of the above

7. The three cardinal rules of 4-H gun safety are: (choose one under each rule)

Rule 1	Rule 2	Rule 3
a. Keep the muzzle pointed up	a. <u>Keep the action open until ready to fire</u>	a. Keep finger in the trigger guard at all times
b. Keep the muzzle pointed down	b. Keep the action closed until ready to fire	b. <u>Keep your finger off the trigger until ready to fire</u>
c. <u>Keep the muzzle pointed in a safe direction</u>	c. Close the action when finished shooting	c. Keep your finger on the trigger while aiming